



---

# User's manual

## FLIR ONE Edge series



# Table of contents

---

<b>1</b>	<b>Notice to user</b> .....	<b>1</b>
1.1	Online documentation .....	1
1.2	Support .....	1
1.3	About this manual .....	1
1.4	Declaration of conformity .....	1
<b>2</b>	<b>Safety information</b> .....	<b>2</b>
<b>3</b>	<b>Camera parts</b> .....	<b>4</b>
<b>4</b>	<b>Quick start guide</b> .....	<b>5</b>
<b>5</b>	<b>Handling the camera</b> .....	<b>6</b>
5.1	General information .....	6
5.2	Charging the battery .....	6
5.3	Turning the camera on and off .....	6
5.4	Connecting the camera .....	6
5.5	Performing a factory reset .....	7
5.6	Updating the camera .....	7
<b>6</b>	<b>Using the FLIR ONE app</b> .....	<b>8</b>
6.1	Camera view .....	8
6.2	Calibration .....	8
6.3	Gallery .....	8
6.4	Cloud storage .....	8
6.5	Drawer menu .....	9
<b>7</b>	<b>Using a thermal camera</b> .....	<b>10</b>
7.1	Measurements .....	10
7.2	Emissivity .....	10
<b>8</b>	<b>Cleaning the camera</b> .....	<b>11</b>
8.1	Camera housing, cables, and other items .....	11
8.2	Infrared lens .....	11
<b>9</b>	<b>Disposal of electronic waste</b> .....	<b>12</b>
9.1	Disassembly for recycling .....	12
<b>10</b>	<b>Disclaimers</b> .....	<b>13</b>
10.1	Legal disclaimer .....	13
10.2	Export controls .....	13
10.3	Patents .....	13
10.4	Quality assurance .....	13
10.5	Third-party licenses .....	13
10.6	Usage statistics .....	13
10.7	Copyright .....	13

## 1.1 Online documentation

Our manuals are continuously updated and published online.

To access the FLIR ONE Edge series user manual and other product documentation, go to <https://support.flir.com/resources/99yx>.

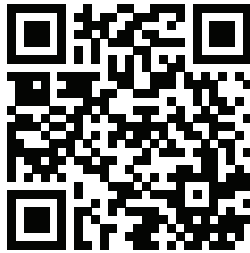

To access the manuals for our other products, as well as manuals for our discontinued products, go to <https://support.flir.com/resources/app>.

## 1.2 Support

Contact our Technical Support Center if you experience problems or have any questions about your product: <https://support.flir.com>.









## 1.3 About this manual

FLIR Systems issues generic manuals that cover several models within a camera series. This means that this manual may contain descriptions and explanations that do not apply to your particular camera model.





The authoritative version of this publication is English. In the event of divergences due to translation errors, the English text has precedence. Any late changes are first implemented in English.

## 1.4 Declaration of conformity

The full text of the Declaration of conformity is available at the following internet address: <https://support.flir.com/resources/99yx>.

 <b>WARNING</b>
<p><b>Applicability:</b> Class B digital devices.</p> <p>This equipment has been tested and found to comply with the limits for a Class B digital device, pursuant to Part 15 of the FCC Rules. These limits are designed to provide reasonable protection against harmful interference in a residential installation. This equipment generates, uses and can radiate radio frequency energy and, if not installed and used in accordance with the instructions, may cause harmful interference to radio communications. However, there is no guarantee that interference will not occur in a particular installation. If this equipment does cause harmful interference to radio or television reception, which can be determined by turning the equipment off and on, the user is encouraged to try to correct the interference by one or more of the following measures:</p> <ul style="list-style-type: none"> <li>• Reorient or relocate the receiving antenna.</li> <li>• Increase the separation between the equipment and receiver.</li> <li>• Connect the equipment into an outlet on a circuit different from that to which the receiver is connected.</li> <li>• Consult the dealer or an experienced radio/TV technician for help.</li> </ul>
 <b>WARNING</b>
<p><b>Applicability:</b> Digital devices subject to 15.19/RSS-GEN.</p> <p><b>NOTICE:</b> This device complies with Part 15 of the FCC Rules and with Industry Canada licence-exempt RSS standard(s). Operation is subject to the following two conditions:</p> <ol style="list-style-type: none"> <li>1. this device may not cause harmful interference, and</li> <li>2. this device must accept any interference received, including interference that may cause undesired operation.</li> </ol>
 <b>WARNING</b>
<p><b>Applicability:</b> Digital devices subject to 15.21.</p> <p><b>NOTICE:</b> Changes or modifications made to this equipment not expressly approved by FLIR Systems may void the FCC authorization to operate this equipment.</p>
 <b>WARNING</b>
<p><b>Applicability:</b> Digital devices subject to 2.1091/2.1093/KDB 447498/RSS-102.</p> <p><b>Radiofrequency radiation exposure Information:</b> For body worn operation, this device has been tested touched to the phantom and meets FCC RF exposure guidelines. Nevertheless, the device should be used in such a manner that the potential for human contact during normal operation is minimized.</p>
 <b>WARNING</b>
<p>This device is granted pursuant to the Japanese Radio Law (電波法) and the Japanese Telecommunications Business Law (電気通信事業法). This device should not be modified (otherwise the granted designation number will become invalid)</p>
 <b>CAUTION</b>
<p>Do not point the infrared camera (with or without the lens cover) at strong energy sources, for example, devices that cause laser radiation, or the sun. This can have an unwanted effect on the accuracy of the camera. It can also cause damage to the detector in the camera.</p>
 <b>CAUTION</b>
<p>Do not use the camera in temperatures more than 50°C (122°F), unless other information is specified in the user documentation or technical data. High temperatures can cause damage to the camera.</p>
 <b>CAUTION</b>
<p>The temperature range through which you can charge the battery is ±0°C to 35°C (32°F to 95°F), except for the Korean market where the approved range is 10°C to 35°C (50°F to 95°F). If you charge the battery at temperatures out of this range, it can cause the battery to become hot or to break. It can also decrease the performance or the life cycle of the battery.</p>

---

 <b>CAUTION</b>
Do not apply solvents or equivalent liquids to the camera, the cables, or other items. Damage to the camera and injury to persons can occur.
 <b>CAUTION</b>
Be careful when you clean the infrared lens. The lens has an anti-reflective coating which is easily damaged. Damage to the infrared lens can occur.
 <b>CAUTION</b>
The 5 GHz band is only allowed for indoor use in Japan and Canada.
 <b>CAUTION</b>
Failure to observe the safety instructions can result in fire, electric shock and other injuries or damage to the device or other property. The housing is made of plastic with sensitive electronic components and batteries inside.
<ul style="list-style-type: none"><li>• Do not pierce, break, crush or cut the device or the battery.</li><li>• Do not expose the device or the battery to an open flame or extremely high temperatures.</li><li>• Do not expose the device or the battery to liquids or extremely low air pressure.</li><li>• Do not drop the device or the battery.</li><li>• Do not try to change the battery in the device.</li><li>• The device or the battery must be recycled or disposed of separately from household waste.</li></ul>
 <b>CAUTION</b>
Be careful if you use the camera to observe very hot objects such as fire and molten metal.

## Camera parts

---

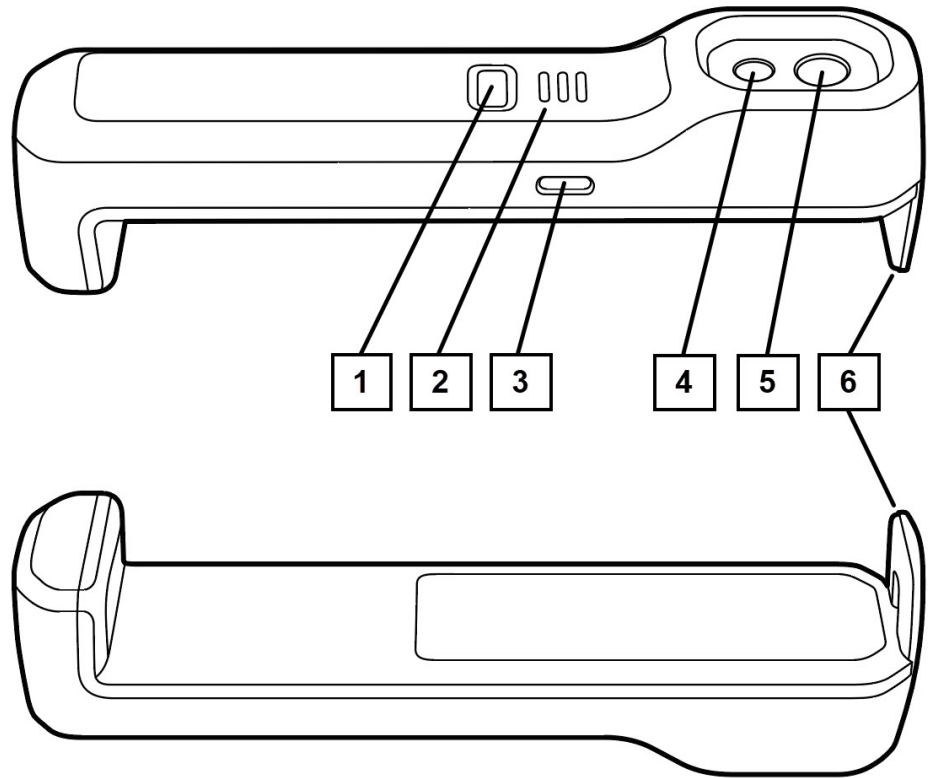

**Figure 3.1** View from the front and from the bottom

1. On/Off button
2. Indicator LEDs
3. USB-C charging port
4. Visual camera
5. Thermal camera
6. Extending arm

1. Install the FLIR ONE app, developed by FLIR Systems, from your preferred app store.



2. Attach the FLIR ONE Edge camera to the back of your mobile device by pulling out the extending arm until the camera is clamped around the device. As an alternative, place the FLIR ONE Edge camera close to your mobile device.

**Note** To prevent damage to the equipment, avoid extending the arm to its end position.

3. To turn on the FLIR ONE Edge camera, press and hold the On/Off button until the LEDs start flashing, indicating that the camera is booting up. It takes about 20 seconds for the camera to start.
4. Start the FLIR ONE app on your mobile device.
5. The FLIR ONE app will guide you to set up the app according to your preferences and to connect (pair) the camera with your mobile device.
6. To turn off the FLIR ONE Edge camera, press and hold the On/Off button until the LEDs turn off.

## 5.1 General information

- When the FLIR ONE Edge camera is connected to your mobile device, it may have impact on the signal strength, compass accuracy, and NFC signaling distance of the device.
- When the FLIR ONE app is paired with the FLIR ONE Edge camera, the mobile device can only connect to the internet via mobile data (not via Wi-Fi).
- If you chose not to physically attach the FLIR ONE Edge camera to your mobile device, the FLIR ONE app will let you know when the distance between the camera and the device becomes too long. If you then continue increasing the distance, you may lose the connection.
- If you forget the password for connecting to the Wi-Fi of the FLIR ONE Edge camera, you need to perform a factory reset of the camera.

## 5.2 Charging the battery

1. Connect a power supply to a wall outlet.
2. Connect the power supply to the USB-C charging port of the FLIR ONE Edge camera.
3. The LEDs on the front of the camera will flash during charging, and then change into a steady light when fully charged.

## 5.3 Turning the camera on and off

- To turn on the FLIR ONE Edge camera, press and hold the On/Off button until the LEDs start flashing, indicating that the camera is booting up. It takes about 20 seconds for the camera to start.
- To turn off the FLIR ONE Edge camera, press and hold the On/Off button until the LEDs turn off.

**Note** If the communication between the FLIR ONE Edge camera and the FLIR ONE app is inactive for more than 7 minutes, the camera automatically turns off.

## 5.4 Connecting the camera

1. Place the FLIR ONE Edge camera close to your mobile device.
2. Make sure the camera is turned on.
3. Start the FLIR ONE app on your mobile device.
4. The FLIR ONE app will guide you to set up the app according to your preferences and to connect (pair) the camera with your mobile device.



## 5.5 Performing a factory reset

If you have forgotten the camera password, you need to perform a factory reset. A reset can also be performed if the camera is not working as expected, for example due to persistent connection problems. After the factory reset, you need to set up the connection again between your camera and your mobile device.

Follow this procedure:

1. Make sure the USB cable is disconnected.
2. Turn off the FLIR ONE Edge camera.
3. Press and hold the On/Off button. Keep holding the button for about 15 seconds, while the LEDs are flashing. When all LEDs show a steady light, immediately release the button.

**Note** You must release the button at the right time, which is a bit tricky. If you release the button too early or too late, the camera will turn off and there will be no factory reset.

4. After a successful factory reset, the camera will reboot and restart. During this process, which can take more than 20 seconds, the LEDs are flashing.

## 5.6 Updating the camera

To take advantage of our latest camera firmware, it is important that you keep your camera updated.

When the FLIR ONE app is connected to the camera and mobile data is available, the app automatically searches for firmware updates. When an update is available, you can update the camera via the FLIR ONE app.

**Note** To update the camera, the mobile device must be connected to the internet via mobile data. Wi-Fi is used for the camera-app connection.

## 6.1 Camera view

When the FLIR ONE Edge camera is connected to the FLIR ONE app, you can see the live view from the camera and take an image or record a video.

The camera view contains functionality to modify the live view:

- **IR Scale:** Hide/show scale. Adjust scale limits.
- **Color:** Choose from nine color palettes.
- **Measurements:** Adjustable measurement spots. Automatic tracking of hottest and coldest spot.
- **Image mode:** Thermal, DC (visual), MSX.
- **MSX Distance:** Align visual and thermal images in MSX mode, depending on distance to object.
- **Temperature range:** Choose suitable object temperature range.

## 6.2 Calibration

The camera automatically calibrates and refreshes the image periodically to provide an optimal image. The thermal camera has a mechanical shutter inside that activates during calibration, which releases a clicking sound. When the shutter activates, the image will freeze for a brief period. When the camera first turns on, and periodically thereafter, the camera will automatically calibrate. It is also possible to manually initiate a calibration in the FLIR ONE app.

## 6.3 Gallery

Captured images and videos can be viewed in the gallery of the FLIR ONE app. Images and videos can also be saved in the gallery of the mobile device, if permission is given. Permissions are set during the initial setup, or later in the FLIR ONE app settings.

Information related to the image is presented in Image details, where it is also possible to add a note to the image.

In the gallery of the FLIR ONE app, images can be edited with the same functionality as in the camera view.

Images and videos can be shared with other apps, for example a social media app on your mobile device.

You can upload images and videos to cloud storage, see section 6.4 *Cloud storage*.

## 6.4 Cloud storage

FLIR Ignite is a cloud storage service for thermal images. In FLIR Ignite, you can view, organize, search for, download, and share your uploaded images.

You can manually upload image and video files from the gallery of the FLIR ONE app to your FLIR Ignite account. You can also set up the app to automatically upload files.

By a setting, you can select to use mobile data for upload to FLIR Ignite. If this setting is turned off, you must disconnect the FLIR ONE app from the FLIR ONE Edge camera and pair the app with a FLIR Ignite account before you can upload files.

To create and access your FLIR Ignite account, go to <https://ignite.flir.com>.

## 6.5 Drawer menu

In the drawer menu you find:

- Settings and account information related to FLIR Ignite.
- Information related to the camera.
- Settings for the FLIR ONE app.
- Help on how to use the app.
- Contact to support.
- Other available apps that are compatible with the FLIR ONE Edge camera.

## 7.1 Measurements

Measurements in thermal cameras show the temperature on the surface of an object. The measurement accuracy depends on many factors, including the distance from the object, the ambient temperature, and the emissivity of the material being observed.

Users are encouraged to learn more about the science of thermography from <https://www.flir.com/support-center/training>.

## 7.2 Emissivity

When the spot meter is enabled, the temperature displayed is affected by many factors, including a property of the target material known as emissivity. This property is a relative rating of how well the target material emits or radiates thermal energy. Some materials are more emissive than others; glossy or reflective materials such as metals tend to be poor emitters. For most materials, the default “matte” setting is a fair approximation.

# Cleaning the camera

## 8.1 Camera housing, cables, and other items

Use one of these liquids:

- Warm water
- A weak detergent solution

Equipment:

- A soft cloth

Follow this procedure:

1. Soak the cloth in the liquid.
2. Twist the cloth to remove excess liquid.
3. Clean the part with the cloth.



### CAUTION

Do not apply solvents or similar liquids to the camera, the cables, or other items. This can cause damage.

## 8.2 Infrared lens

Use one of these liquids:

- A commercial lens cleaning liquid with more than 30% isopropyl alcohol.
- 96% ethyl alcohol (C<sub>2</sub>H<sub>5</sub>OH).

Equipment:

- Cotton wool



### CAUTION

If you use a lens cleaning cloth it must be dry. Do not use a lens cleaning cloth with the liquids that are listed above. These liquids can cause material on the lens cleaning cloth to become loose. This material can have an unwanted effect on the surface of the lens.

Follow this procedure:

1. Soak the cotton wool in the liquid.
2. Twist the cotton wool to remove excess liquid.
3. Clean the lens one time only and discard the cotton wool.



### WARNING

Make sure that you read all applicable MSDS (Material Safety Data Sheets) and warning labels on containers before you use a liquid: the liquids can be dangerous.



### CAUTION

- Be careful when you clean the infrared lens. The lens has a delicate anti-reflective coating.
- Do not clean the infrared lens too vigorously. This can damage the anti-reflective coating.

Waste of Electrical and Electronic Equipment (WEEE) poses a risk to human health and the environment when not disposed of properly. This product should not be discarded as unsorted waste but must be sent to separate collection facilities for recovery and recycling. More information is available from the relevant local authority.



## 9.1 Disassembly for recycling

Before disposal of the camera, disassemble the camera and discard the parts separately.

1. Use a thin knife to lift a corner of the product label. Remove the product label.
2. Use a Torx T6 screwdriver and remove the two screws from the back cover. Remove the back cover.
3. Disconnect the battery connector by lifting the side knob of the connector. Pull out the battery.
4. Remove the gap pad.
5. Use a Torx T6 screwdriver and remove the four screws that hold the electronics assembly. Lift out the electronics assembly.

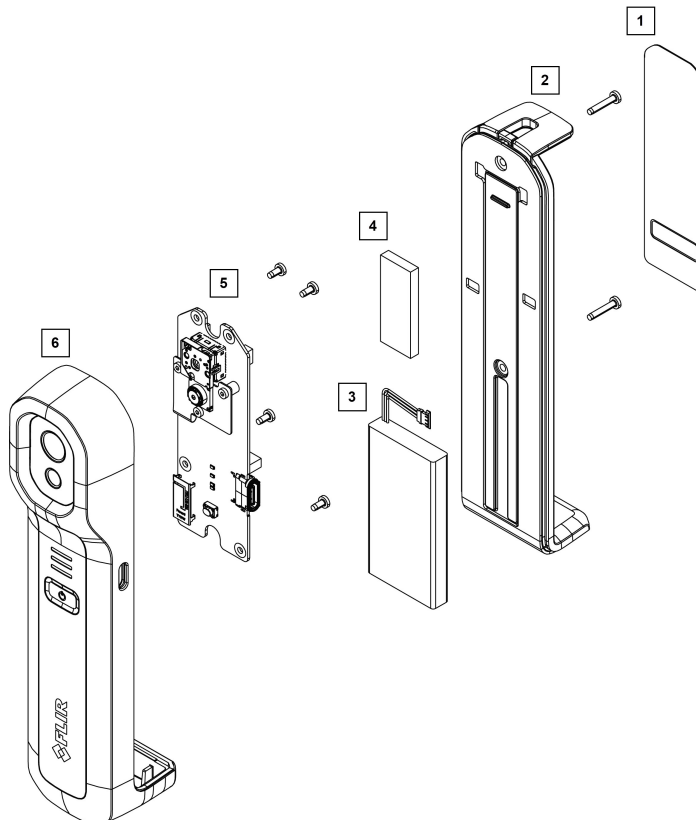

1. Product label: Plastic (PET)
2. Back cover: Metal (Zinc, Steel), Silicone rubber, PU foam
3. Battery: Li-ion
4. Gap pad: HC5000 (silicone, fiberglass)
5. Electronics assembly: circuit board, components
6. Camera body: Plastic (PC-ABS), Glass (BK7, Si), Metal (Aluminum), PU foam

## 10.1 Legal disclaimer

For warranty terms, refer to <https://www.flir.com/warranty>.

## 10.2 Export controls

Products described herein may be subject to export regulations.

This document does not contain export-controlled information.

## 10.3 Patents

This product is protected by patents, design patents, patents pending, or design patents pending. Refer to the FLIR Systems' patent registry:

<https://www.flir.com/patentnotices>

## 10.4 Quality assurance

The Quality Management System under which these products are developed and manufactured has been certified in accordance with the ISO 9001 standard.

FLIR Systems is committed to a policy of continuous development; therefore we reserve the right to make changes and improvements on any of the products without prior notice.

## 10.5 Third-party licenses

Information about third-party licenses is available in the user interface of the product.

## 10.6 Usage statistics

FLIR Systems reserves the right to gather anonymous usage statistics to help maintain and improve the quality of our software and services.

## 10.7 Copyright

© 2023 FLIR Systems, Inc. All rights reserved worldwide. No parts of the software including source code may be reproduced, transmitted, transcribed or translated into any language or computer language in any form or by any means, electronic, magnetic, optical, manual or otherwise, without the prior written permission of FLIR Systems.

The documentation must not, in whole or part, be copied, photocopied, reproduced, translated or transmitted to any electronic medium or machine readable form without prior consent, in writing, from FLIR Systems.

Names and marks appearing on the products herein are either registered trademarks or trademarks of FLIR Systems and/or its subsidiaries. All other trademarks, trade names or company names referenced herein are used for identification only and are the property of their respective owners.



---

**Website**

<http://www.flir.com>

**Customer support**

<http://support.flir.com>

**Copyright**

© 2023, FLIR Systems, Inc. All rights reserved worldwide.

**Disclaimer**

Specifications subject to change without further notice. Models and accessories subject to regional market considerations. License procedures may apply. Products described herein may be subject to US Export Regulations. Please refer to [exportquestions@flir.com](mailto:exportquestions@flir.com) with any questions.

Publ. No.: T810603  
Release: AE  
Commit: 93321  
Head: 93321  
Language: en-US  
Modified: 2023-09-18  
Formatted: 2023-09-18