

# EE771

## Flow Sensor for Compressed Air and Gases DN15 (1/2") - DN50 (2")

The EE771 is ideal for flow measurement in pipelines with diameters of DN15 (1/2") up to DN50 (2"). Besides the temperature (T) the sensor provides the values for standardized volumetric flow ( $V'_n$ ), standardized flow ( $v_n$ ) and mass flow ( $m'$ ). The integrated totalizer records the consumption ( $Q_n$ ). The sensor is suitable for air, nitrogen, CO<sub>2</sub>, O<sub>2</sub>, argon or other non-corrosive, non-flammable gases with a pressure of up to 16 bar (232 psi).

### Precision and Reliability

The EE771 sets new standards in terms of measurement accuracy and reproducibility thanks to its application-specific factory adjustment at 7 bar. A dynamic pressure compensation via a 2-wire 4 - 20 mA input is available. The E+E hot film sensing element deploying the latest thin film technology features excellent long-term stability, fast response time and an outstanding reliability.

### Easy Mounting

The unique mounting concept including a measurement valve with shut-off function permits rapid installation and removal of the device with only short flow interruption. It ensures high measurement accuracy through exact and reproducible sensing head positioning in the pipe.

### Versatile Output Options

The EE771 features two freely scalable outputs configurable as analogue current or voltage output, switch output or as pulse output for consumption measurement. Optionally, the measured data is available at the Modbus RTU or M-BUS (Meter-Bus) interface.

### User Configurable and Adjustable

The free EE-PCS Product Configuration Software and an optional configuration adapter facilitate the configuration and adjustment of the EE771.



## Features

### Measurands

- » Standard volume flow ( $V'_n$ )
- » Mass flow ( $m'$ )
- » Standard flow ( $v_n$ )
- » Temperature (T)
- » Consumption ( $Q_n$ )

### Probe with hot film sensing element

- » Robust design in stainless steel
- » Highly insensitive to contamination
- » Broad working range of 1:400
- » High accuracy  $\pm 1.5\%$  of reading
- » Long-term stability and high reproducibility
- » Factory adjustment under pressure

### Measurement valve with shut-off function

- » Fail-safe alignment of sensing unit
- » Service friendly due to  $< 15$  s flow interruption for sensor unit installation
- » Best accuracy due to precise and reproducible positioning of the sensing head
- » Pressure rating 16 bar (232 psi)
- » Sealing plug allows for running the process also without sensor.

### Consumption metering

- » Consumption meter (totalizer) for cost-effective analysis
- » Counter value on the display
- » Stored in non-volatile memory
- » Available on pulse output

### Display

- » Shows actual, min / max values and overall consumption
- » Layout with 1 or 2 lines

### Output

- » User configurable via PC
- » 0 - 10 V/4 - 20 mA output
- » Two switch outputs
- » Pulse output
- » Modbus RTU
- » M-Bus

Inspection certificate according to DIN EN 10204-3.1

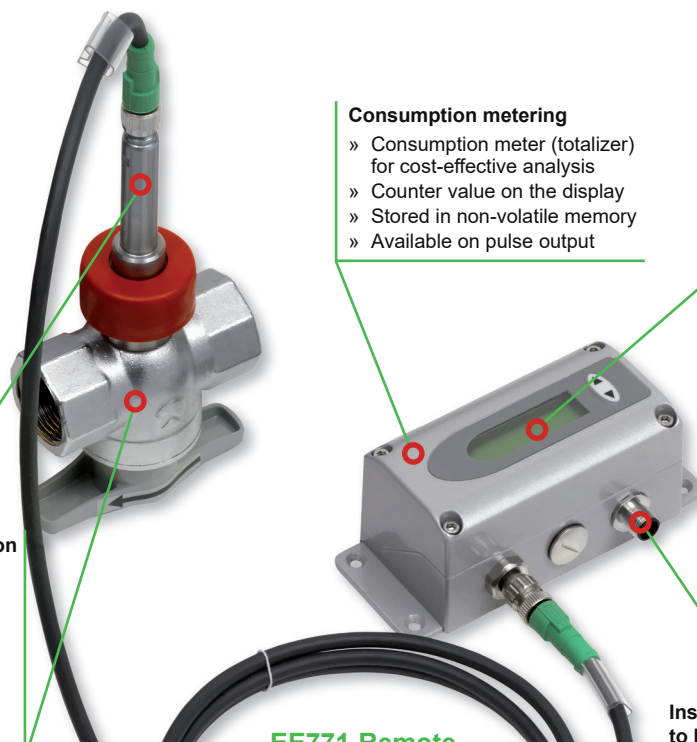

## Dimensions

Values in mm (inch)

### EE771 Compact

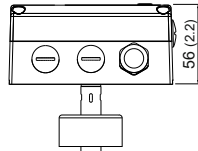
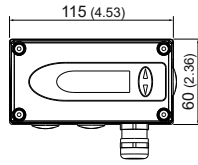

### EE771-T19/EE771-T20

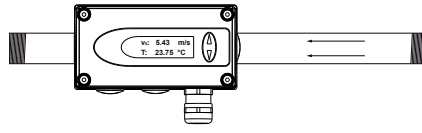

**EE771-T20** direction of flow is right to left

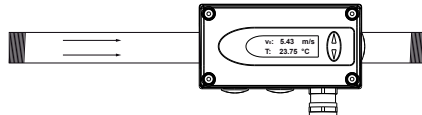

**EE771-T19** direction of flow is left to right

### EE771 Remote

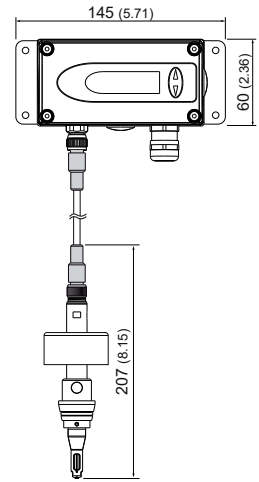

### EE771-T3

### Measurement valve with shut-off function

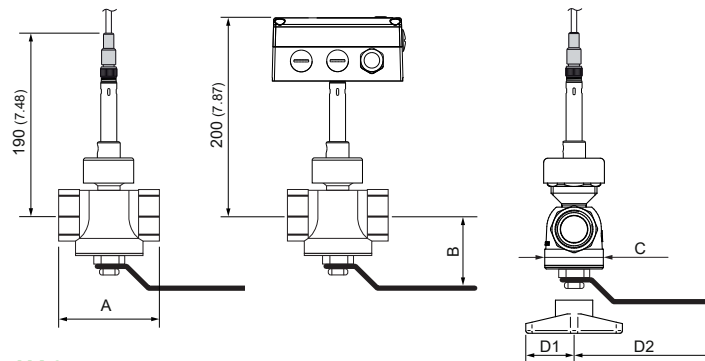

### HA075xxx

| Valve | Thread <sup>1)</sup>         | A                               | B         | C         | D1        | D2         | ISO      | NPT           |
|-------|------------------------------|---------------------------------|-----------|-----------|-----------|------------|----------|---------------|
| DN15  | R <sub>p</sub> 1/2"          | 100±8 (3.94±0.32) <sup>2)</sup> | 55 (2.28) | 43 (1.69) | 36 (1.46) | –          | HA075015 | not available |
| DN20  | R <sub>p</sub> or NPT 3/4"   | 73 (2.83)                       | 55 (2.28) | 43 (1.69) | 36 (1.46) | –          | HA075020 | HA175020      |
| DN25  | R <sub>p</sub> or NPT 1"     | 88 (3.27)                       | 67 (2.28) | 52 (2.00) | 48 (1.73) | –          | HA075025 | HA175025      |
| DN32  | R <sub>p</sub> 1 1/4"        | 100 (3.94)                      | 77 (2.64) | 62 (2.44) | –         | 125 (4.88) | HA075032 | not available |
| DN40  | R <sub>p</sub> or NPT 1 1/2" | 110 (4.33)                      | 83 (3.27) | 74 (2.91) | –         | 147 (5.79) | HA075040 | HA175040      |
| DN50  | R <sub>p</sub> or NPT 2"     | 131 (5.16)                      | 88 (3.46) | 90 (3.54) | –         | 147 (5.79) | HA075050 | HA175050      |

1) Female thread: BSP thread acc. to EN 10226 (old DIN 2999) or NPT

2) Including reduction 3/4"-1/2"

## Flow measuring range as function of operating pressure

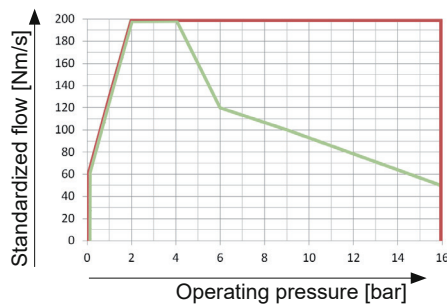

### Formula for standardized volumetric flow:

$$V'_n = v_n \cdot id^2 \cdot \pi/4 \cdot 3600$$

$V'_n$  ... Standardized volumetric flow [m<sup>3</sup>/h]

$v_n$  ... Standardized flow [m/s]

$id$  ... Inner pipe diameter [m]

$\pi$  ... 3,1415279

— Air, nitrogen, O<sub>2</sub>, argon

— CO<sub>2</sub>

## Technical data

### Measurands

| <b>Flow</b>  |                | Volumetric flow at standard conditions acc. to DIN 1343<br>$p_0 = 1013.25 \text{ mbar (14.7 psi)}$ ; $T_0 = 0 \text{ °C (32 °F)}$ |                   |                               |                   |
|--|----------------|---|-------------------|-------------------------------|-------------------|
| Measuring range  |                | <b>HV31</b>   |                   | <b>HV33</b>                   |                   |
| Standardized volumetric flow in air  | DN15 (1/2"):   | 0.32...63 Nm <sup>3</sup> /h  | 0.19...37.1 SCFM  | 0.32...126 Nm <sup>3</sup> /h | 0.19...74.1 SCFM  |
|  | DN20 (3/4"):   | 0.57...113 Nm <sup>3</sup> /h   | 0.34...66.5 SCFM  | 0.57...226 Nm <sup>3</sup> /h | 0.34...133 SCFM   |
|  | DN25 (1"):     | 0.90...176 Nm <sup>3</sup> /h   | 0.53...103.5 SCFM | 0.90...352 Nm <sup>3</sup> /h | 0.53...207.1 SCFM |
|  | DN32 (1 1/4"): | 1.45...289 Nm <sup>3</sup> /h   | 0.85...170.0 SCFM | 1.45...578 Nm <sup>3</sup> /h | 0.85...340 SCFM   |
|  | DN40 (1 1/2"): | 2.26...452 Nm <sup>3</sup> /h   | 1.33...265.9 SCFM | 2.26...904 Nm <sup>3</sup> /h | 1.33...531.8 SCFM |
| Standardized flow in air, CO <sub>2</sub> ,<br>nitrogen, argon<br>O <sub>2</sub> | ≤DN50 (2"):    | 0.5...100 Nm/s  | 100...19685 SFPM  | 0.5...200 Nm/s                | 100...39370 SFPM  |
|  | DN65 (2 1/2"): |   |                   | 0.5...117 Nm/s                | 100...23031 SFPM  |
|  | ≤DN25 (1"):    | 0.5...100 Nm/s  | 100...19685 SFPM  | 0.5...200 Nm/s                | 100...39370 SFPM  |
| Accuracy in air at 7 bar (abs) (101.5 psi) and 23°C (73°F) <sup>1)</sup>         |                | ± (1.5 % of measuring value + 0.5 % of full scale)  |                   |                               |                   |
| Temperature dependency   |                | ± (0.1 % of measuring value/°C)   |                   |                               |                   |
| Pressure dependency <sup>2)</sup>  |                | 0.5 % of measuring value / bar  |                   |                               |                   |
| Response time $t_{90}$   |                | < 1 s   |                   |                               |                   |
| Sample rate  |                | 0.1 s   |                   |                               |                   |
| <b>Temperature</b>   |                |   |                   |                               |                   |
| Measuring range  |                | -20...80 °C (-4...176 °F)   |                   |                               |                   |
| Accuracy at 20°C (68°F)  |                | ± 0.7 °C (1.26 °F)  |                   |                               |                   |

### Outputs

#### Signal range and measurands are freely configurable

|                                     |   |                         |                          |
|-------------------------------------|---|-------------------------|--------------------------|
| Analogue output                     | Voltage   | 0 - 10 V                | $0 < I_L < 1 \text{ mA}$ |
|                                     | Current (3-wire)  | 0 - 20 mA and 4 - 20 mA | $R_L < 500 \text{ Ohm}$  |
| Switch output                       | Potential-free, max. 44 V DC, 500 mA switching capacity             |                         |                          |
| Pulse output                        | Totalizer, pulse length: 0.02...2 s                                 |                         |                          |
| <b>Digital interface (optional)</b> |   |                         |                          |
| RS485                               | (EE771 = 1 unit load)   |                         |                          |
| Protocol                            | Modbus RTU  |                         |                          |
| Default settings                    | Baud rate 9600 <sup>3)</sup> , parity even, stop bits 1, slave ID 1 |                         |                          |
| M-Bus                               |   |                         |                          |
| Default settings                    | Baud rate 2400 <sup>4)</sup> , parity even, stop bits 1, slave ID 1 |                         |                          |

### Input

|                               |  |
|-------------------------------|--|
| Dynamic pressure compensation | 4 - 20 mA (2-wire; 15 V) input for pressure sensor |
|-------------------------------|--|

### General

|                               |  |                              |
|-------------------------------|--|------------------------------|
| Supply voltage                | 18 - 30 V AC/DC  |                              |
| Current consumption, max      | 200 mA (with display)  |                              |
| Temperature range             | Ambient, storage: -20...60 °C (-4...140 °F)  |                              |
|                               | Medium: -20...80 °C (-4...176 °F)  |                              |
| Nominal pressure              | 16 bar (232 psi)   |                              |
| Humidity                      | 0...100 %RH, non-condensing  |                              |
| Electrical connection         | Cable gland M16 and screw terminals max. 1.5 mm <sup>2</sup> (AWG 16), optional with connector M12x1, 8 pole |                              |
| Electromagnetic compatibility | EN 61326-1   |                              |
|                               | EN 61326-2-3   |                              |
| Material                      | Enclosure  | Metal (AlSi <sub>3</sub> Cu) |
|                               | Probe  | Stainless steel              |
|                               | Sensor head  | Stainless steel / glass      |
|                               | Measurement valve  | Brass                        |
| Enclosure protection rating   | IP65 / NEMA 4  |                              |



1) The accuracy statement includes the uncertainty of the factory calibration with an enhancement factor  $k=2$  (2-times standard deviation). The accuracy was calculated in accordance with EA-4/02 and with regard to GUM (Guide to the Expression of Uncertainty in Measurement). The accuracy specifications apply when using inlet and outlet sections of suitable length, see accessories and User Manual

2) The flow meter is calibrated at 7 bar (abs) (101.5 psi). At other working pressure the error can be compensated by setting the actual pressure with the configuration software.

3) Supported baud rates: 9600, 19200, 38400 and 57600; find more details about communication setting in the User Manual and the Modbus Application Note at [www.epluse.com/ee771](http://www.epluse.com/ee771).

4) Supported baud rates: 600, 1200, 2400, 4800 and 9600; find more details about communication setting in the User Manual.

## Ordering Guide

The EE771 consists of the sensor (pos. 1) and the measurement valve with shut-off function (pos. 2). Both have to be ordered together! The probe cable (pos. 3) is only necessary for model T3.

| Position 1 - Sensor                             |  |                                   |   | EE771-            |                   |  |
|---|--|-----------------------------------|---|-------------------|-------------------|--|
| Hardware Configuration                          | Model                                    | Compact ri-le                     | flow direction right to left                              | T19               |                   |  |
|   |  | Compact le-ri                     | flow direction left to right                              | T20               |                   |  |
|   |  | Remote                            |   | T3                |                   |  |
|   | Measuring range                          | 0...100 m/s (328.1 ft/s)          |   | HV31              |                   |  |
|   |  | 0...200 m/s (656.2 ft/s)          |   | HV33              |                   |  |
|   | Measurement valve for pipe diameter      | DN15 (1/2")                       |   | N15               |                   |  |
|   |  | DN20 (3/4")                       |   | N20               |                   |  |
| DN25 (1")                                       |  | N25                               |   |                   |                   |  |
| DN32 (1 1/4")                                   |  | N32                               |   |                   |                   |  |
| DN40 (1 1/2")                                   |  | N40                               |   |                   |                   |  |
| DN50 (2")                                       |  | N50                               |   |                   |                   |  |
| Display   | Without display                          |                                   | no code   |                   |                   |  |
|   | With display                             |                                   | D2  |                   |                   |  |
| Mounting  | Measurement valve with shut-off function |                                   | no code   |                   |                   |  |
| Electrical connection                           | Cable gland and screw terminals          |                                   | no code   |                   |                   |  |
|   | 1 plug for power supply and outputs      |                                   | E4  |                   |                   |  |
| Digital output                                  | No digital output                        |                                   | no code   |                   |                   |  |
|   | Modbus RTU                               |                                   | J3  |                   |                   |  |
|   | M-Bus                                    |                                   | J5  |                   |                   |  |
| Software Setup <sup>1)</sup>                    | Measurand output 1                       | Temperature                       | T [°C]  | MA1               |                   |  |
|   |  |                                   | T [°F]  | MA2               |                   |  |
|   |  | Standardized volumetric flow      | V <sub>n</sub> [Nm <sup>3</sup> /h]                       | MA83              |                   |  |
|   |  |                                   | V <sub>n</sub> [ft <sup>3</sup> /min]                     | MA87              |                   |  |
|   |  | Mass flow                         | m' [kg/h]   | MA80              |                   |  |
|   | Signal output 1                          | Analogue output                   | 0 - 5 V   |                   | GA2               |  |
|   |  |                                   | 0 - 10 V  |                   | GA3               |  |
|   |  |                                   | 0 - 20 mA   |                   | GA5               |  |
|   |  | Switching output                  | 4 - 20 mA   |                   | GA6               |  |
|   |  |                                   |   |                   | GA9               |  |
|   | Measurand output 2                       | Temperature                       | T [°C]  | MB1               |                   |  |
|   |  |                                   | T [°F]  | MB2               |                   |  |
|   |  | Standardized volumetric flow      | V <sub>n</sub> [Nm <sup>3</sup> /h]                       | MB83              |                   |  |
|   |  |                                   | V <sub>n</sub> [ft <sup>3</sup> /min]                     | MB87              |                   |  |
|   |  | Mass flow                         | m' [kg/h]   | MB80              |                   |  |
|   |  | Standardized flow                 | v <sub>n</sub> [Nm/s]                                     | MB22              |                   |  |
|   |  |                                   | v <sub>n</sub> [ft/min]                                   | MB23              |                   |  |
|   | Signal output 2                          | Consumption <sup>2)</sup>         | Q <sub>n</sub> [Nm <sup>3</sup> ]                         | MB91              |                   |  |
|   |  | Q <sub>n</sub> [ft <sup>3</sup> ] | MB93  |                   |                   |  |
| Switch output                                   |  |                                   |   | GB9               |                   |  |
| Medium  | Pulse output                             |                                   |   | GB10              |                   |  |
|   | Air                                      |                                   |   | no code           |                   |  |
|   | Nitrogen                                 |                                   |   | FU2               |                   |  |
|   | CO <sub>2</sub>                          |                                   |   | FU3               |                   |  |
|   | O <sub>2</sub> <sup>3)</sup>             |                                   |   | FU4               |                   |  |
|   | Argon                                    |                                   |   | FU7               |                   |  |
| <b>Position 2 - Measurement valve</b>           |  |                                   |   | <b>BSP Thread</b> | <b>NPT Thread</b> |  |
| DN15 - measurement valve                        | <b>HA075015</b>                          | not available                     | DN15 - measurement valve for O <sub>2</sub> <sup>3)</sup> | <b>HA076015</b>   | not available     |  |
| DN20 - measurement valve                        | <b>HA075020</b>                          | <b>HA175020</b>                   | DN20 - measurement valve for O <sub>2</sub> <sup>3)</sup> | <b>HA076020</b>   | <b>HA176020</b>   |  |
| DN25 - measurement valve                        | <b>HA075025</b>                          | <b>HA175025</b>                   | DN25 - measurement valve for O <sub>2</sub> <sup>3)</sup> | <b>HA076025</b>   | <b>HA176025</b>   |  |
| DN32 - measurement valve                        | <b>HA075032</b>                          | not available                     |   |                   |                   |  |
| DN40 - measurement valve                        | <b>HA075040</b>                          | <b>HA175040</b>                   |   |                   |                   |  |
| DN50 - measurement valve                        | <b>HA075050</b>                          | <b>HA175050</b>                   |   |                   |                   |  |
| <b>Position 3 - Probe cable (Model T3 only)</b> |  |                                   |   |                   |                   |  |
| Cable length                                    | 2 m (6.56 ft)                            | <b>HA010816</b>                   |   |                   |                   |  |
|   | 5 m (16.4 ft)                            | <b>HA010817</b>                   |   |                   |                   |  |
|   | 10 m (32.8 ft)                           | <b>HA010818</b>                   |   |                   |                   |  |

1) Can be changed by the user.

2) Consumption measurement is only possible with pulse output (output 2 = GB10).

3) Medium O<sub>2</sub> only for mounting valve DN15 up to DN25. Upon delivery, the mounting valve and the probe are free of oil and grease.

## Order Example

### Position 1 - Sensor

#### EE771-T19HV31N25MA83GA6MB91GB10

Model: Compact ri-le  
 Measuring range: 0...100 m/s (328.1 ft/s)  
 Measuring pipe-diameter: DN25 (1")  
 Display: No display  
 Mounting: Measurement valve with shut-off function  
 Electrical connection: Cable gland

Digital output: No digital output  
 Phys. parameter output 1: Standardized vol. flow [Nm<sup>3</sup>/h]  
 Output 1: 4 - 20 mA  
 Phys. parameter output 2: Consumption [Nm<sup>3</sup>/h]  
 Output 2: Pulse output  
 Medium: Air

### Position 2 - Measurement valve

#### HA075025

DN25 - measurement valve with shut-off function

### Position 3 - Probe cable

Necessary for model T3 only.

## Ordering Guide Accessories

---

|  |                    |          |
|--|--------------------|----------|
| - Inlet and outlet section for measurement valve | DN15 <sup>*)</sup> | HA070215 |
|  | DN20 <sup>*)</sup> | HA070220 |
|  | DN25 <sup>*)</sup> | HA070225 |
|  | DN32 <sup>*)</sup> | HA070232 |
|  | DN40 <sup>*)</sup> | HA070240 |
|  | DN50 <sup>*)</sup> | HA070250 |

<sup>\*)</sup> Inlet and outlet pipe section is available for measurement valve with BSP thread only.