



User Manual

**EE212**

**Modular Humidity/Temperature Sensor**

YOUR PARTNER IN SENSOR TECHNOLOGY



**ELEKTRONIK®**  
Ges.m.b.H.

E+E Elektronik Ges.m.b.H. does not accept warranty and liability claims neither upon this publication nor in case of improper treatment of the described products.

The document may contain technical inaccuracies and typographical errors. The content will be revised on a regular basis. These changes will be implemented in later versions. The described products can be improved and changed at any time without prior notice.

© Copyright E+E Elektronik Ges.m.b.H. All rights reserved.

**EMC note USA (FCC):**

This equipment has been tested and found to comply with the limits for a Class A digital device, pursuant to part 15 of the FCC Rules. These limits are designed to provide reasonable protection against harmful interference when the equipment is operated in a commercial environment. This equipment generates, uses, and can radiate radio frequency energy and, if not installed and used in accordance with the instruction manual, may cause harmful interference to radio communications. Operation of this equipment in a residential area is likely to cause harmful interference in which case the user will be required to correct the interference at his own expense.

**EMC note Canada (ICES-003):**

CAN ICES-3 (A) / NMB-3 (A)

# CONTENT

<b>1</b>	<b>General</b> .....	<b>4</b>
1.1	Explanation of Symbols .....	4
1.2	Safety Instructions .....	4
1.2.1	General Safety Instructions .....	4
1.2.2	Intended Use .....	4
1.2.3	Mounting, Start-up and Operation .....	5
1.3	Environmental Aspects .....	5
1.4	ESD Protection .....	5
<b>2</b>	<b>Scope of Supply</b> .....	<b>5</b>
<b>3</b>	<b>Product Description</b> .....	<b>5</b>
3.1	General .....	5
3.2	Dimensions .....	6
3.3	Electrical Connection .....	6
3.4	Display .....	8
<b>4</b>	<b>Mounting and Installation</b> .....	<b>8</b>
<b>5</b>	<b>Setup and Configuration</b> .....	<b>8</b>
5.1	EE-PCS Product Configuration Software .....	8
<b>6</b>	<b>Maintenance and Service</b> .....	<b>10</b>
6.1	Sensing Module Replacement .....	10
6.2	Filter Cap Exchange .....	11
6.3	Display Change .....	11
6.4	Repairs .....	11
6.5	Spare Parts .....	11
<b>7</b>	<b>Technical Data</b> .....	<b>12</b>

# 1 General

This user manual serves for ensuring proper handling and optimal functioning of the device. The user manual shall be read before commissioning the equipment and it shall be provided to all staff involved in transport, installation, operation, maintenance and repair. The user manual may not be used for the purposes of competition without the written consent of E+E Elektronik and may not be forwarded to third parties. Copies may be made for internal purposes. All information, technical data and diagrams included in these instructions are based on the information available at the time of writing.

## Disclaimer

The manufacturer or his authorized agent can be only be held liable in case of willful or gross negligence. In any case, the scope of liability is limited to the corresponding amount of the order issued to the manufacturer. The manufacturer assumes no liability for damages incurred due to failure to comply with the applicable regulations, operating instructions or the specified operating conditions. Consequential damages are excluded from the liability.

## 1.1 Explanation of Symbols



**This symbol indicates safety information.**

It is essential that all safety information is strictly observed. Failure to comply with this information can lead to personal injuries or damage to property. E+E Elektronik assumes no liability if this happens.



**This symbol indicates instructions.**

The instructions shall be observed in order to reach optimal performance of the device.

## 1.2 Safety Instructions

### 1.2.1 General Safety Instructions

- The EE212 enclosure, the sensing probe and the sensing module shall not be exposed to unnecessary mechanical stress.
- The EE212 electronics is sensitive to electrostatic discharge (ESD), appropriate protective measures should be taken when touching it.
- Installation, electrical connection, maintenance and commissioning shall be performed by qualified personnel only.
- Use the EE212 only as intended and observe all technical specifications.
- Do not use EE212 in explosive atmosphere or for measurement of aggressive gases.
- This device is not appropriate for safety, emergency stop or other critical applications where device malfunction or failure could cause injury to human beings.

### 1.2.2 Intended Use

The EE212 is a RH / T sensor for demanding applications in climate control, pharmaceutical and agricultural industries. It is available for wall or duct mounting.

The use of the EE212 in any other way than described in this manual bears a safety risk for people and the entire measurement installation and is therefore not allowed.

The manufacturer cannot be held responsible for damages as a result of incorrect handling, installation, and maintenance of the device.

In order to avoid damage to the device or health hazards, the device may not be manipulated with tools other than specifically described in this manual.

The EE212 may only be utilized in accordance with the stipulations of the present user manual and the specification in chapter 7 Technical Data. Otherwise, measurement inaccuracy might occur and failures cannot be ruled out.

### 1.2.3 Mounting, Start-up and Operation

The EE212 has been produced under state of the art manufacturing conditions, has been thoroughly tested and has left the factory after fulfilling all safety criteria. The manufacturer has taken all precautions to ensure safe operation of the device. The user must ensure that the device is set up and installed in a manner that does not have a negative effect on its safe use. The user is responsible for observing all applicable safety guidelines, local and international, with respect to safe installation and operation of the device. This user manual contains information and warnings that must be observed by the user in order to ensure safe operation.



- Mounting, start-up, operation and maintenance of the device may be performed by qualified staff only. Such staff must be authorized by the operator of the facility to carry out the mentioned activities.
- The qualified staff must have read and understood this user manual and must follow the instructions contained within.
- All process and electrical connections shall be thoroughly checked by authorized staff before putting the device into operation.
- Do not install or start-up a device supposed to be faulty. Make sure that such devices are not accidentally used by marking them clearly as faulty.
- A faulty device may only be investigated and possibly repaired by qualified, trained and authorized staff. If the fault cannot be fixed, the device shall be removed from the process.
- Service operations other than described in this user manual may only be performed by the manufacturer.

## 1.3 Environmental Aspects



Products from E+E Elektronik are developed and manufactured in compliance with all relevant environmental protection requirements. Please observe local regulations for the device disposal.



For disposal, the individual components of the device must be separated according to local recycling regulations. The electronics shall be disposed of correctly as electronics waste.

## 1.4 ESD Protection

The sensing elements and the electronics board are ESD (electrostatic discharge) sensitive components of the device and must be handled as such. The failure to do so may damage the device by electrostatic discharges when touching exposed sensitive components.

## 2 Scope of Supply

- EE212 Modular RH / T Sensor according to ordering guide
- Mounting flange for duct mount version (Type T2)
- Inspection certificate according to DIN EN 10204-3.1
- Test report according to DIN EN 10204-2.2

## 3 Product Description

### 3.1 General

The EE212 is a RH / T sensor for demanding applications in climate control, pharmaceutical and agricultural industries. It is available for wall or duct mounting. Besides measuring RH and T, the sensor calculates the following values:

- Absolute humidity
- Dew point temperature
- Enthalpy
- Frostpoint temperature
- Mixing ratio
- Water vapor partial pressure
- Wet bulb temperature

The measured and calculated data is available as analogue current or voltage output.

The pluggable sensing module can easily be exchanged on-site with only short downtime. Refer to chapter 6.1 for details on sensing module exchange.

For a setup deviating from default, the EE212 can be configured manually by means of the free EE-PCS Product Configuration Software. Refer to chapter 5 Setup and Configuration for details.

The optional display features backlight and shows up to 3 measurands including the symbol of the physical quantity and the measurement unit. The font size automatically adapts to the number of lines.

### 3.2 Dimensions

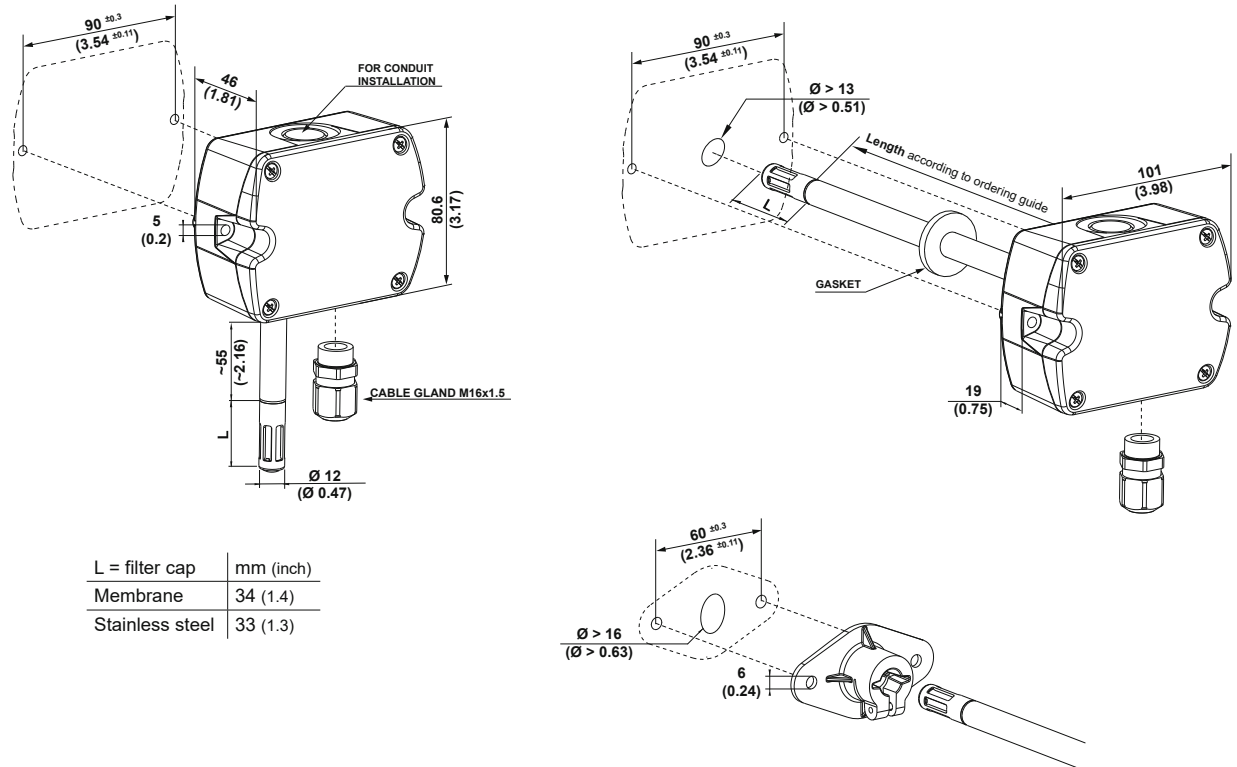

Fig. 1 EE212 dimensions in mm (inch)

### 3.3 Electrical Connection

EE212 features screw terminals for connecting the power supply and the analogue outputs. The cables are fed into the enclosure through the M16x1.5 cable gland.



**Important:**

Make sure that the cable glands are closed tightly for the power supply and outputs cable. This is necessary for assuring the IP rating of the enclosure according to EE212 specification, as well as for stress relief at the screw terminals on the EE212 board.



**Important:**

The manufacturer cannot be held responsible for personal injuries or damage to property as a result of incorrect handling, installation, wiring, power supply and maintenance of the device.

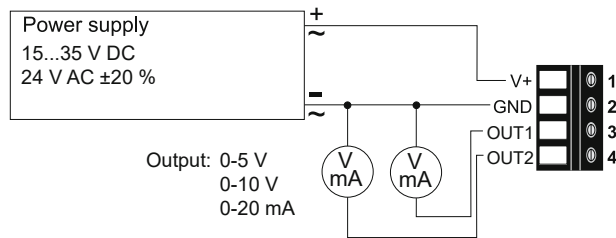
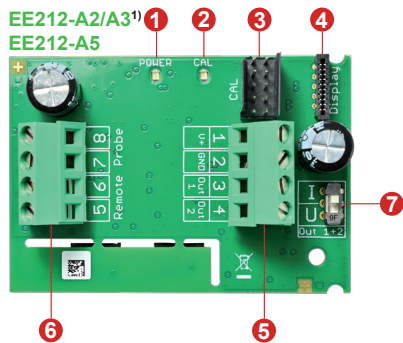
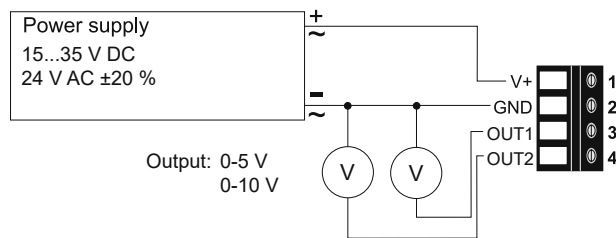
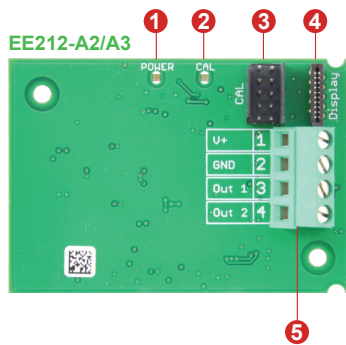
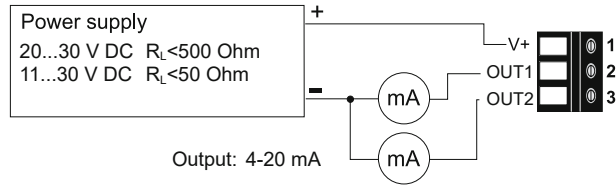
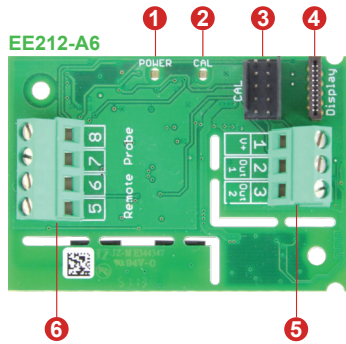

1) When ordered with option D2 (display with backlight)

Fig. 2 EE212 connection options

No.	Function
1	Green LED
	Information during operation
	On..... normal operation Flashing... the main board does not recognize the probe's measurement electronics Off..... no power supply or main board failure
2	Blue LED
	Information during setup with the optional USB configuration adapter HA011066 and the EE-PCS Product Configuration Software
	On..... USB connection to PC, no communication with EE-PCS Flashing... communication with EE-PCS in progress Off..... no USB connection to PC
3	Configuration connector (USB configuration adapter)
4	FFC cable socket for the display
5	Screw terminals for power supply and analogue outputs
6	Screw terminals, do not connect
7	Output signal (I/U) selection

Tab. 1 EE212 electronics board components

## 3.4 Display

In factory setting the display shows the two parameters selected for output 1 and output 2 (according to ordering code). The user can change the display layout to 1, 2 or 3 lines and select the parameters to be displayed. Refer to chapter 5 Setup and Configuration for details.



**Please note:** The display is available as spare part, intended for replacement only, not for retrofitting an EE212 originally ordered without display.



**Important:** The EE212 (4...20 mA, two-wire version) with display operates correctly only if both outputs are connected.

## 4 Mounting and Installation

For best measurement results, the EE212

- must be installed in an environment where the medium to be measured flows sufficiently around the probe.
- shall not be placed near heating radiators or fan heaters.

## 5 Setup and Configuration

The EE212 is ready to use and does not require any configuration by the user. The factory setup of EE212 corresponds to the type number ordered. Please refer to the data sheet at [www.epluse.com/EE212](http://www.epluse.com/EE212). If needed, the user can change the factory setup with the help of the free EE-PCS Product Configuration Software and the USB configuration adapter (HA011066).

The user can change the display settings and the output configuration. Refer to chapter 5.1 for details.



**Please note:** The EE212 may not be connected to any additional power supply when using the USB configuration adapter HA011066.

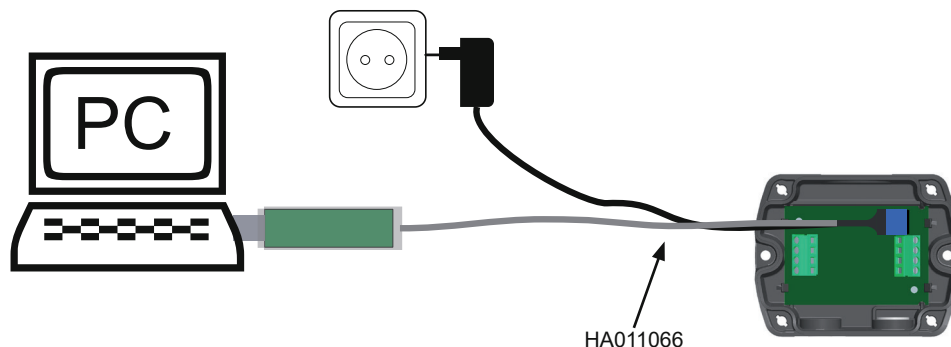

Fig. 3 EE212 connected to a PC running EE-PCS

### 5.1 EE-PCS Product Configuration Software

To use the software for performing adjustments and changes in settings, please proceed as follows:

1. Download the EE-PCS Product Configuration Software from [www.epluse.com/configurator](http://www.epluse.com/configurator) and install it on the PC.
2. Connect the E+E device to the PC using the USB configuration adapter.
3. Start the EE-PCS software.
4. Follow the instructions on the EE-PCS opening page for scanning the ports and identifying the connected device
5. Click on the desired setup or adjustment mode from the main EE-PCS menu on the left and follow the online instructions of the EE-PCS



Analogue output configuration options:

- Measurand assignment
- Current and/or voltage scaling
- Unit selection
- Output value fixing (measured value or current/voltage value)

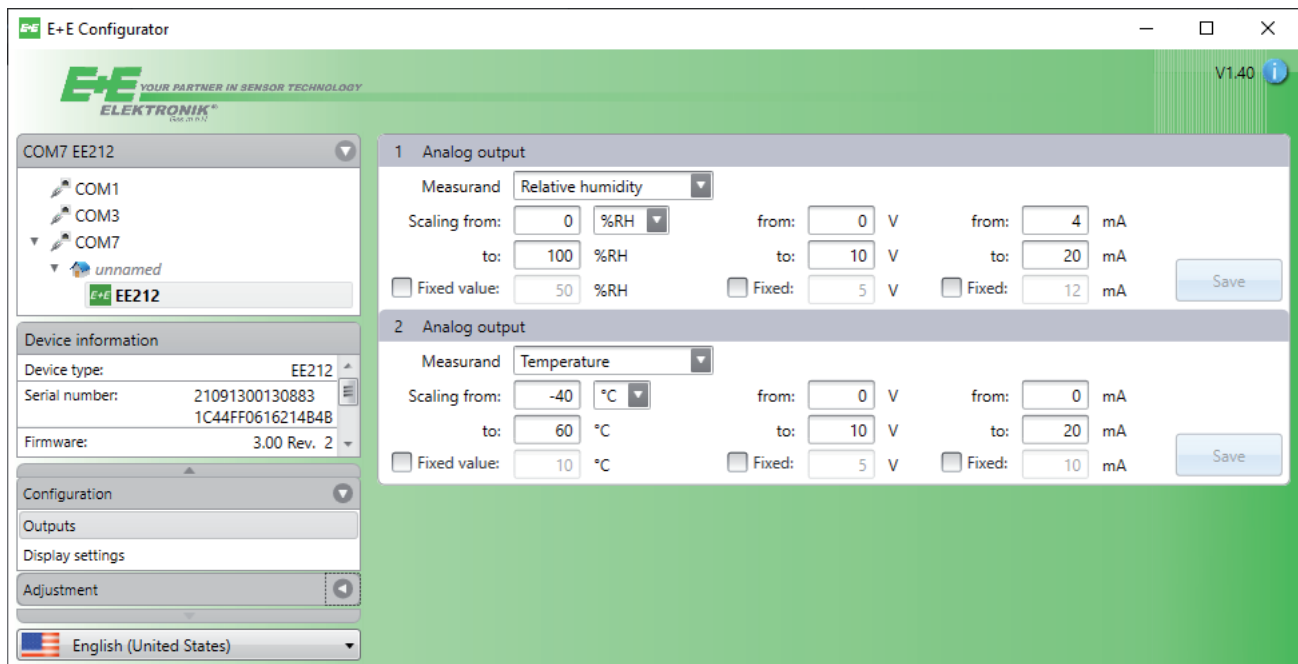

Fig. 4 EE212 with current or voltage output (selectable)

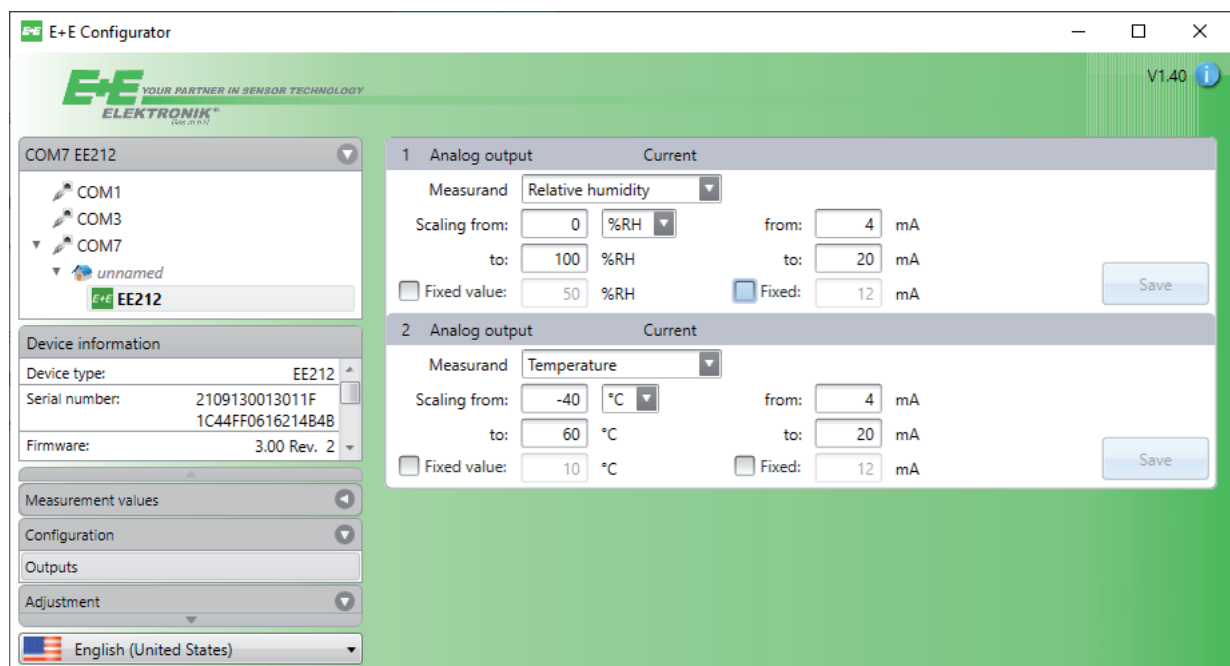

Fig. 5 EE212 with current output

Display configuration options:

- Display layout
- Measurand selection
- Display appearance (backlight, brightness, contrast)

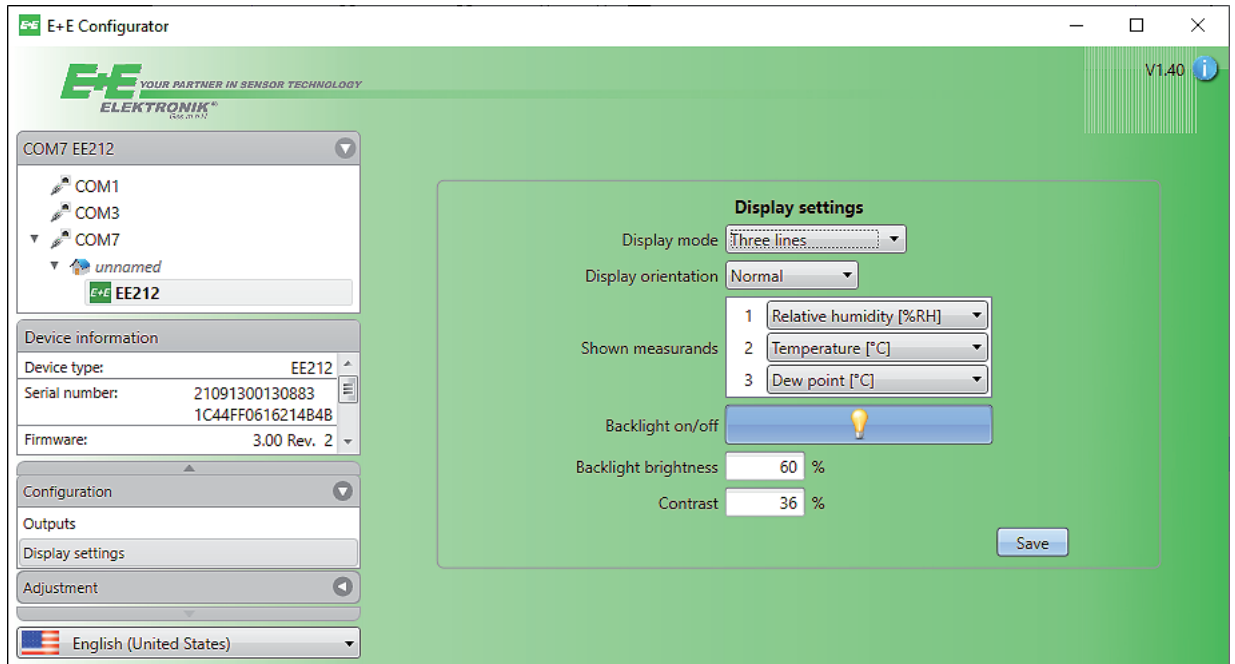

Fig. 6 EE212 display configuration

## 6 Maintenance and Service

### 6.1 Sensing Module Replacement

If needed, the EE212M sensing module can be replaced by a new one. Please refer to chapter 6.5 for the order code.



Extreme working conditions such as highly polluted, aggressive and chemically contaminated environment might require periodical maintenance of the device. The maintenance is facilitated by the modular design. The replacement of the sensor module under above conditions represents a standard maintenance operation, whereby the sensor module is a wear component. Refer to chapter 6.5 for the order code. A possible measurement drift or the failure of the sensing module caused by harsh working environment are excluded from any warranty claims.



For a newly ordered EE212M sensing module the inspection certificate according to DIN EN 10204-3.1 is available online only from <https://certificates.epluse.com/>. The serial number is lasered onto the module as a 2D bar code. Please refer to Fig. 7.



Fig. 7 Location of EE212M serial number 2D bar code

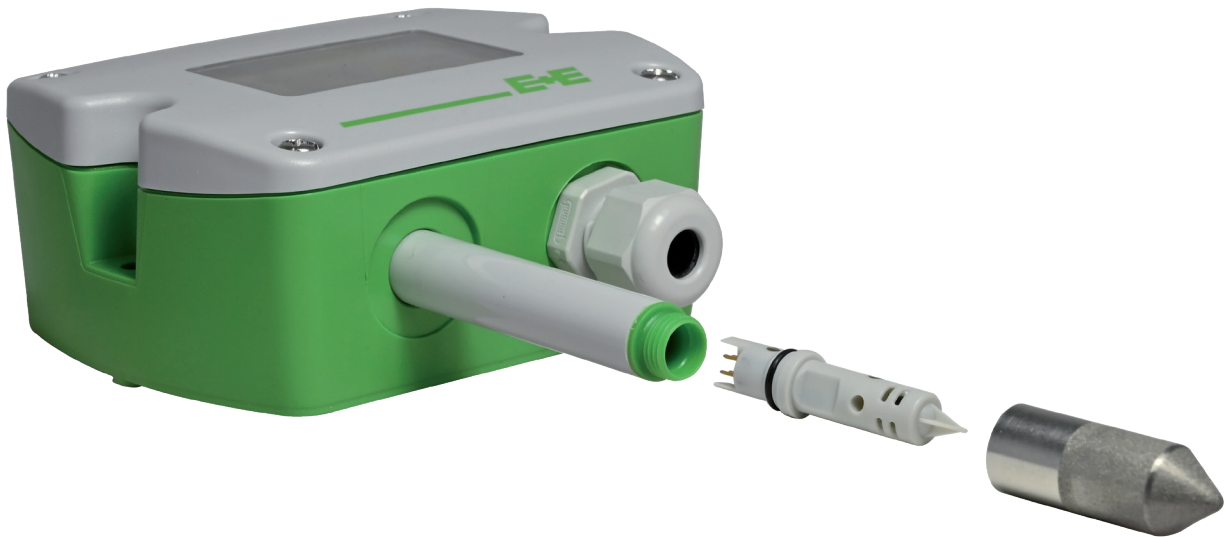

Fig. 8 EE212 modular construction



Power off EE212 before connecting or disconnecting the sensing module. Failing to do so may cause damages to EE212 and to the module.



#### Procedure:

- Power off the EE212.
- Remove the filter cap by turning it counter-clockwise.
- Remove the sensing module by pulling it straight out from the probe.
- Plug the new EE212M sensing module into the output unit.
- Screw the filter cap fingertight onto the probe.
- Power on the EE212

## 6.2 Filter Cap Exchange

In a dusty, polluted environment it might be necessary to replace the filter cap once in a while. In most of the cases, a clogged filter shows visible contamination or dirt. Longer response time of the measurement also indicates a clogged filter cap. In such cases, replace the filter by a new, original one, see data sheet “Accessories”.

### Procedure:



- Turn the filter cap counter-clockwise for removing it.
- Install the new filter cap fingertight by turning it clockwise.

## 6.3 Display Change

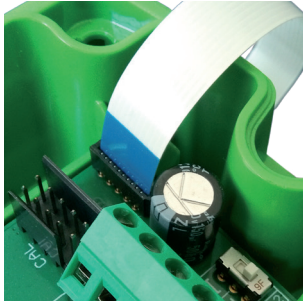

Fig. 9 Display and FFC cable connection on the EE212 electronics board

When connecting the display's FFC cable to the EE212 electronics board, please observe the correct orientation. The blue cable stiffener needs to be on the left side as shown in Fig. 9.



Power off EE212 before connecting or disconnecting the display. Failing to do so may cause damages to EE212 and to the display.

## 6.4 Repairs

Repairs may be carried out by the manufacturer only. The attempt of unauthorized repair excludes any warranty claims.

## 6.5 Spare Parts

Display for EE212<sup>1)</sup>

**D09P**

Sensing Module for EE212

Single packed

**EE212M-PK4**

Multipackage / Tray<sup>2)</sup>

**EE212M-PK6**

1) For replacement only, not for retrofitting an EE212 without display

2) Minimum order quantity: 10 pcs

For accessories refer to the EE212 data sheet at [www.eplusee.com/EE212](http://www.eplusee.com/EE212) and to the “Accessories” data sheet.

# 7 Technical Data

## Measurands

### Relative Humidity

Working range 0...100 %RH

Accuracy<sup>1</sup> (incl. hysteresis, non-linearity and repeatability)

@ 23 °C (73 °F)  $\pm(1.5 + 0.005 \cdot mv)$  %RH

-15...60 °C (5...140 °F)  $\pm(1.8 + 0.007 \cdot mv)$  %RH

-40...-15 °C (-40...5 °F) Additional uncertainty  $\pm 0.125$  %RH/°C<sup>2</sup>

mv = measured value

### Temperature

Accuracy

$\pm \Delta T$  [°C]

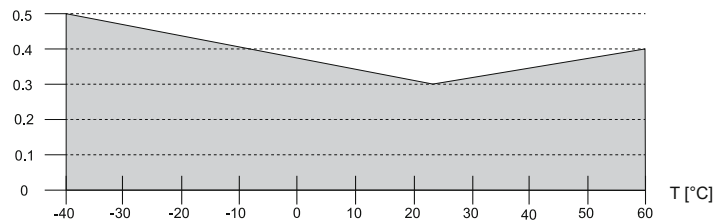

## Outputs

### Analogue output

0 - 5 V / 0 - 10 V      -1 mA < I<sub>L</sub> < 1 mA

4 - 20 mA (2-wire)      R<sub>L</sub> ≤ 500 Ω

0 - 20 mA (3-wire)      R<sub>L</sub> ≤ 500 Ω

## General

Power supply class III 

for 4 - 20 mA (2-wire)

$(10 \text{ V} + R_L \times 20 \text{ mA}) < V_+ < 30 \text{ V DC}$

for 0 - 20 mA (3-wire)

15 - 35 V DC<sup>3</sup> or 24 V AC ±20 %

for 0 - 5 V / 0 - 10 V

Current consumption at 24 V

Voltage output

DC supply max. 12 mA;

with display max. 23 mA

AC supply max. 34 mA<sub>rms</sub>;

with display max. 49 mA<sub>rms</sub>

Current output

2-wire

DC supply max. 40 mA;

with display max. 40 mA

3-wire

DC supply typ. 33 mA;

with display max. 44 mA

AC supply typ. 65 mA<sub>rms</sub>;

with display max. 84 mA<sub>rms</sub>

Display

1, 2 or 3 lines, user configurable, optional with backlight

Electrical connection

Screw terminals, max. 1.5 mm<sup>2</sup>

Enclosure material

Polycarbonate, UL94V-0 (with Display UL94HB) approved

Protection rating

IP65/NEMA 4

Cable gland

M16 x 1.5

Electromagnetic compatibility

EN 61326-1:2013

EN 61326-2-3:2013

Industrial Environment

FCC Part15 Class A    ICES-003 Class A



Temperature ranges

Working: -40...60 °C (-40...140 °F)

without display

Storage: -40...60 °C (-40...140 °F)

Temperature ranges

Working: -20...50 °C (-4...122 °F)

with display

Storage: -20...60 °C (-4...140 °F)

1) Traceable to international standards, administrated by NIST, PTB, BEV,... The accuracy statement includes the uncertainty of the factory calibration with an enhancement factor k=2 (2-times standard deviation). The accuracy was calculated in accordance with EA-4/02 and with regard to GUM (Guide to the Expression of Uncertainty in Measurement).

2) Deviating from -15 °C (5 °F)

3) USA & Canada class 2 supply required, max. supply voltage 30 V DC



#### HEADQUARTERS

##### **E+E Elektronik Ges.m.b.H.**

Langwiesen 7  
4209 Engerwitzdorf  
Austria  
Tel.: +43 7235 605-0  
E-mail: [info@epluse.com](mailto:info@epluse.com)  
Web: [www.epluse.com](http://www.epluse.com)

#### SUBSIDIARIES

##### **E+E Elektronik China**

18F, Kaidi Financial Building,  
No.1088 XiangYin Road  
200433 Shanghai  
Tel.: +86 21 6117 6129  
E-mail: [info@epluse.cn](mailto:info@epluse.cn)

##### **E+E Elektronik France**

Le Norty III, 136 chemin du Moulin  
69130 Ecully  
Tel.: +33 4 74 72 35 82  
E-mail: [info@epluse.fr](mailto:info@epluse.fr)

##### **E+E Elektronik Germany**

Schöne Aussicht 8 C  
61348 Bad Homburg  
Tel.: +49 6172 13881-0  
E-mail: [info@epluse.de](mailto:info@epluse.de)

##### **E+E Elektronik Italy**

Via Alghero 17/19  
20128 Milano (MI)  
Tel.: +39 02 2707 86 36  
E-mail: [info@epluse.it](mailto:info@epluse.it)

##### **E+E Elektronik Korea**

Suite 2001, Heungdeok IT  
Valley Towerdong, 13,  
Heungdeok 1-ro, Giheung-gu  
16954 Yongin-si, Gyeonggi-do  
Tel.: +82 31 732 6050  
E-mail: [info@epluse.co.kr](mailto:info@epluse.co.kr)

##### **E+E Elektronik USA**

333 East State Parkway  
Schaumburg, IL 60173  
Tel.: +1 847 490 0520  
E-mail: [office@epluse.com](mailto:office@epluse.com)

YOUR PARTNER IN SENSOR TECHNOLOGY



**ELEKTRONIK®**  
Ges.m.b.H.